

A & M Electric Tools

Rotary Hammers

Ind Product No. Type
a 4000405979 PLH26QE

Voltage Country
220-240V IN2

Milwaukee

PLH 26 QE

Exp.view No. Version Date Page
4926 4059 80 0001 11.03.08 1/3

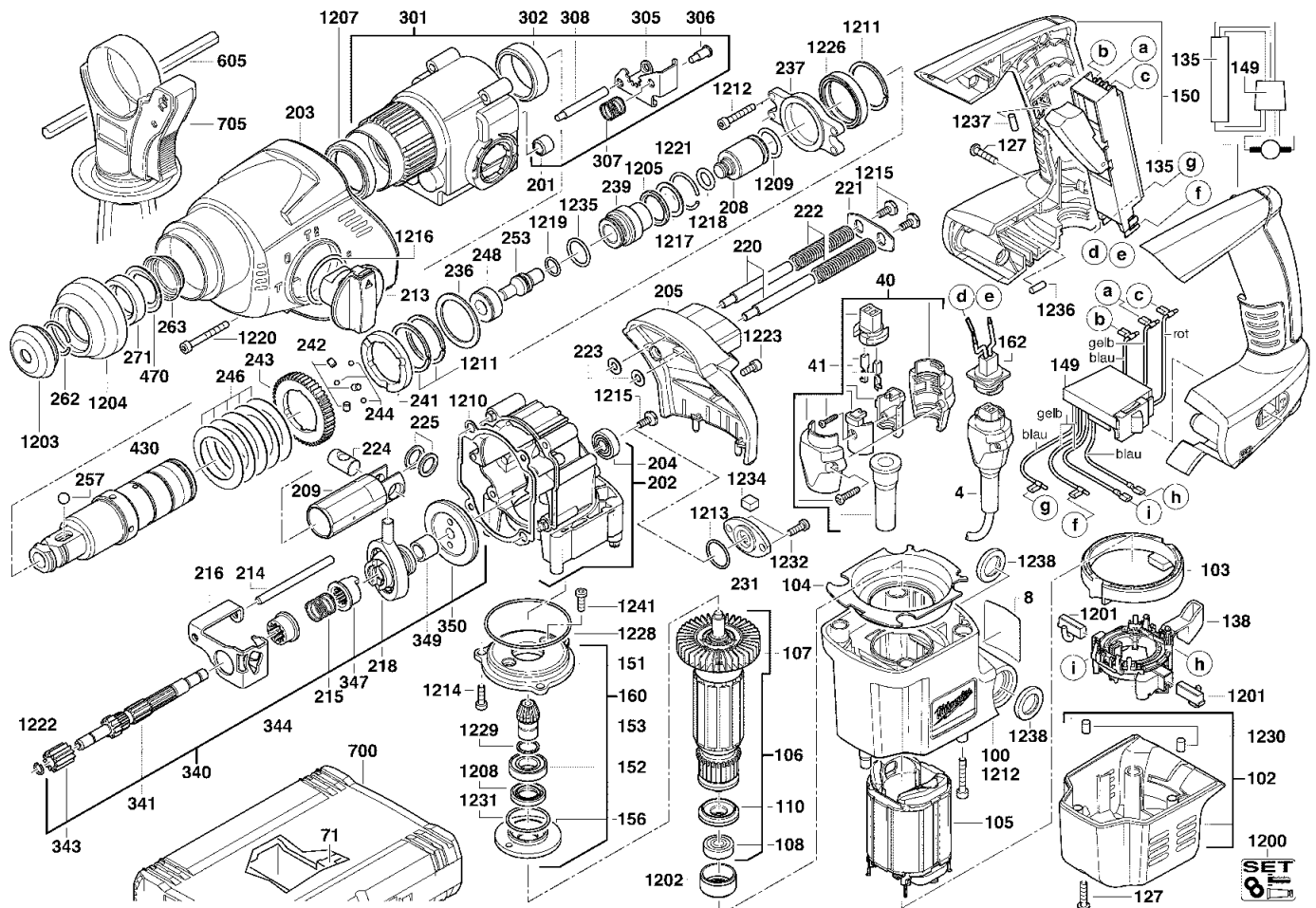

Pos	Index	Quanti	Article No.	Designation	Pos	Index	Quanti	Article No.	Designation
0004	a.....	1	4931624171	CONNECTION CABLE	0156	a.....	1	4931392742	BEARING COVER
0008	a.....	1	4931405982	RATING PLATE	0160	a.....	1	4931396414	BEARING END PLATE
0040	a.....	1	4931380758	REPAIR KIT	0162	a.....	1	4931364437	INSERT
0041	a.....	1	4931380763	CABLE SOCKET P./10	0201	a.....	1	4931933756	NEEDLE BEARING
0071	a.....	1	4931392099	INSERT	0202	a.....	1	4931400846	GEAR BOX
0100	a.....	1	4931392634	MOTOR HOUSING	0203	a.....	1	4931392716	GEAR BOX INSULATIO
0102	a.....	1	4931392446	MOTOR CAP	0204	a.....	1	4931623951	BALL BEARING
0103	a.....	1	4931384662	HOLDING-DOWN DEVIC	0205	a.....	1	4931392717	GEAR COVER
0104	a.....	1	4931392636	AIR DEFLECTOR RING	0208	a.....	1	4931392376	PERCUSSION BODY
0105	a.....	1	4931368355	ELECTRIC FIELD	0209	a.....	1	4931392472	CYLINDER
0106	a.....	1	4931384656	ARMATURE	0213	a.....	1	4931384621	SWITCH HANDLE
0107	a.....	1	4931372559	FAN	0214	a.....	1	4931624279	CYLINDER PIN
0108	a.....	1	4931902888	BALL BEARING	0215	a.....	1	4931365058	SPRING
0110	a.....	1	4931385658	INSULATING DISC	0216	a.....	1	4931384617	SLIDING SWITCH
0127	a.....	7	4931624515	SCREW	0218	a.....	1	4931365013	WOBBLE DRIVE
0135	a.....	1	4931384668	SWITCH	0220	a.....	2	4931384667	GUIDE BOLT
0138	a.....	1	4931392637	SET COLLAR	0221	a.....	1	4931384669	LATCH PLATE
0149	a.....	1	4931384663	ELECTRIC ELEMENT	0222	a.....	2	4931384670	PRESSURE SPRING
0150	a.....	1	4931392639	HANDLE COMPL.	0223	a.....	2	4931909973	DISC
0151	a.....	1	4931384626	BEARING END PLATE	0224	a.....	1	4931365056	CYLINDRICAL BOLT
0152	a.....	1	4931624278	BALL BEARING	0225	a.....	2	4931365112	DISC
0153	a.....	1	4931384615	PINION	0231	a.....	1	4931392461	BEARING COVER

Repairs/modification and testing of electric power tools are to be carried out by specialists. The safety regulations according to DIN/VDE/CEE/AFNOR and other regulations valid in the different countries are to be observed.

A & M Electric Tools

Rotary Hammers

Ind Product No. Type
a 4000405979 PLH26QE

Voltage Country
220-240V IN2

Milwaukee

PLH 26 QE

Exp.view No. Version Date Page

4926 4059 80 0001 11.03.08 2/3

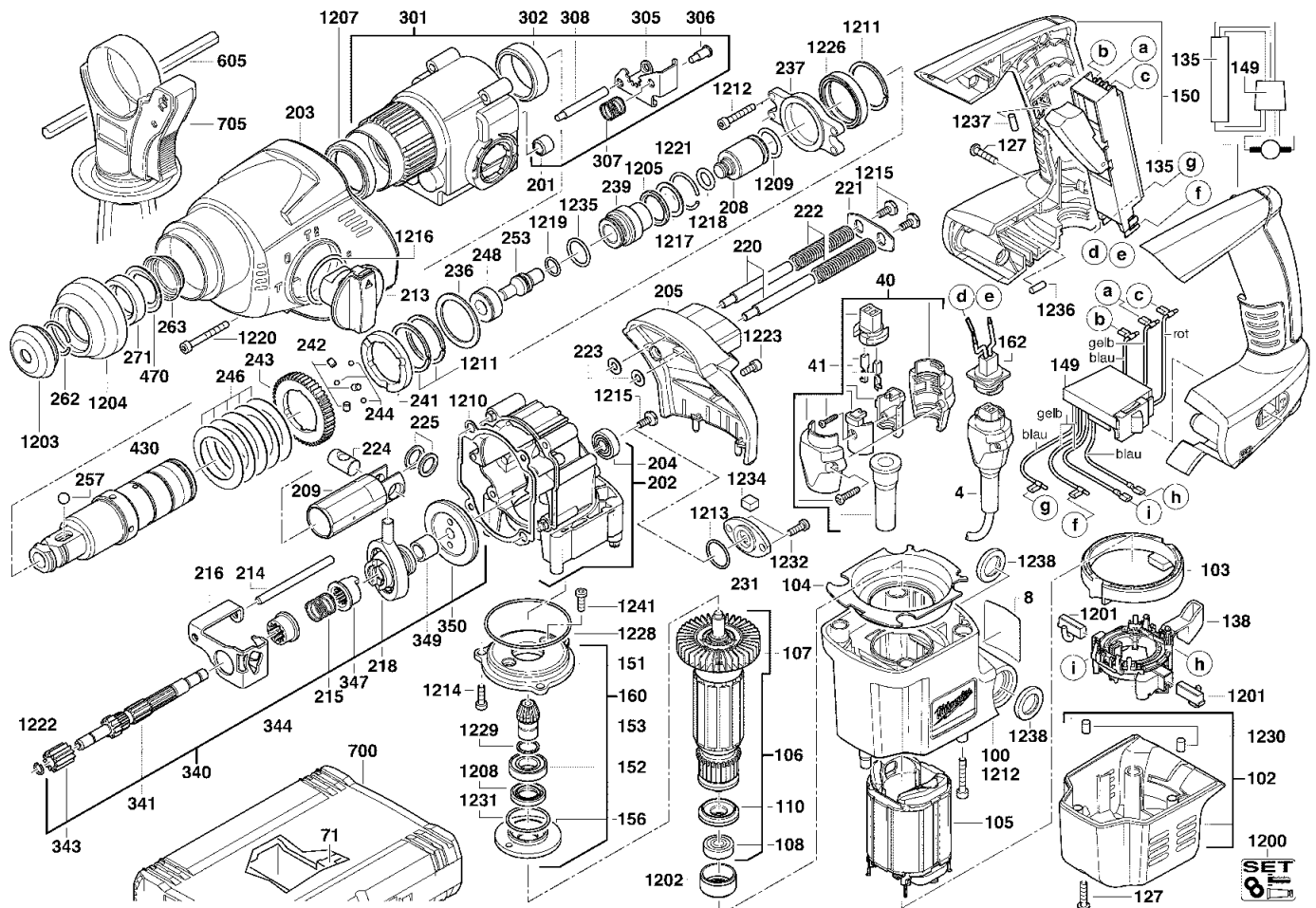

Pos	Index	Quanti	Article No.	Designation	Pos	Index	Quanti	Article No.	Designation
0236	a.....	1	4931624257	WASHER	0343	a.....	1	4931384611	GEAR
0237	a.....	1	4931392455	ENDPLATE	0344	a.....	1	4931375874	INTERN.GEARED WHE
0239	a.....	1	4931384608	SLEEVE	0347	a.....	1	4931384691	COUPLING SLEEVE
0241	a.....	1	4931392751	CLUTCH DISC	0349	a.....	1	4931384613	DISTANCE SLEEVE
0242	a.....	3	4931365057	CYLINDRICAL BOLT	0350	a.....	1	4931384614	BEVEL GEAR
0243	a.....	1	4931392489	SPINDLE GEAR	0430	a.....	1	4931394117	REPAIR KIT
0244	a.....	3	4931944281	BALL	0470	a.....	1	4931394116	REPAIR KIT
0246	a.....	5	4931365066	CUP SPRING	0605	a.....	1	4931384434	DEPTH GAUGE
0248	a.....	1	4931392465	STOP WASHER	0700	a.....	1	4932378986	CARRYING CASE
0253	a.....	1	4931384606	SNAP DIE	0705	a.....	1	4931392747	HANDLE
0257	a.....	1	4931911572	BALL	1200	a.....	1	4931400959	MAINTENANCE SET
0262	a.....	1	4931623220	SPRING RING	1201	a.....	1	4931392459	CARBON BRUSH SET
0263	a.....	1	4931343128	PRESSURE SPRING	1202	a.....	1	4931351729	RUBBER SLEEVE
0271	a.....	1	4931384635	HOLDING RING	1203	a.....	1	4931384687	RUBBER CAP
0301	a.....	1	4931384632	GEAR BOX	1204	a.....	1	4931384634	SLEEVE
0302	a.....	1	4931621944	NEEDLE BEARING	1205	a.....	1	4931624391	SEAL RING
0305	a.....	1	4931384618	LOCKING PLATE	1207	a.....	1	4931624259	SEAL RING
0306	a.....	1	4931384619	GUIDE BOLT	1208	a.....	1	4931624429	SEAL RING
0307	a.....	1	4931384631	PRESSURE SPRING	1209	a.....	1	4931624533	SEAL RING
0308	a.....	1	4931384690	GUIDE BOLT	1210	a.....	1	4931375894	SEAL
0340	a.....	1	4931384609	REDUCT. GEAR SHAFT	1211	a.....	3	4931945764	SPRING RING
0341	a.....	1	4931384610	REDUCT. GEAR SHAFT	1212	a.....	8	4931624582	SCREW

Repairs/modification and testing of electric power tools are to be carried out by specialists. The safety regulations according to DIN/VDE/CEE/AFNOR and other regulations valid in the different countries are to be observed.

A & M Electric Tools

Rotary Hammers

Ind Product No. Type
a 4000405979 PLH26QE

Voltage Country
220-240V IN2

Milwaukee
PLH 26 QE

Exp.view No. Version Date Page
4926 4059 80 0001 11.03.08 3/3

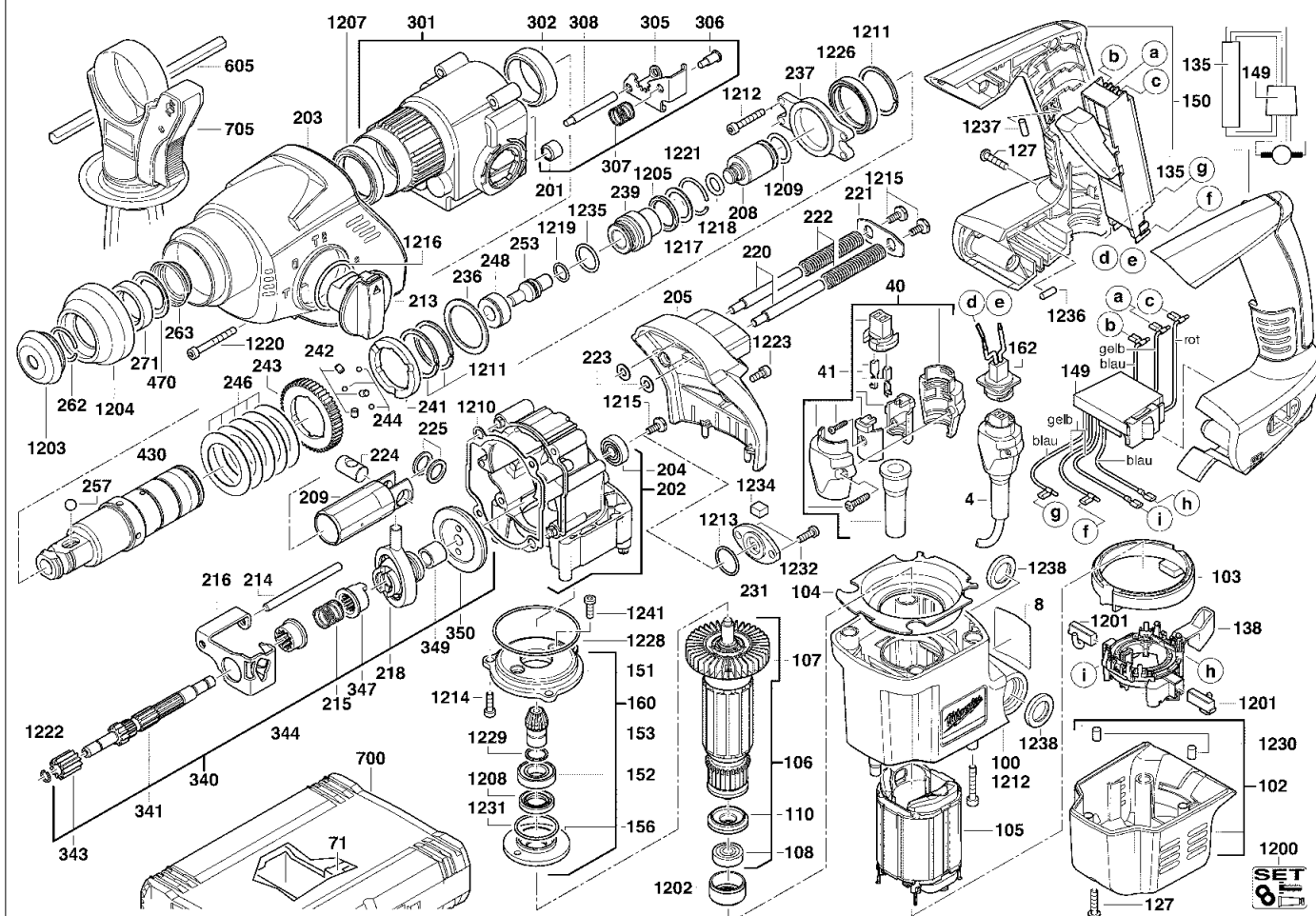

Pos	Index	Quanti	Article No.	Designation
1213	a.....	1	4931623912	SEAL RING
1214	a.....	3	4931624581	SCREW
1215	a.....	3	4931375897	SCREW
1216	a.....	1	4931624353	SEAL RING
1217	a.....	1	4931392464	THRUST COLLAR
1218	a.....	1	4931387380	O-RING
1219	a.....	1	4931624493	SEAL RING
1220	a.....	4	4931624583	SCREW
1221	a.....	1	4931623860	SPRING RING
1222	a.....	1	4931624260	SPRING RING
1223	a.....	2	4931624581	SCREW
1226	a.....	1	4931365188	DAMPING RING
1228	a.....	1	4931623198	O-RING
1229	a.....	1	4931622084	SPRING RING
1230	a.....	1	4931271824	HOLDING-DOWN DEVIC
1231	a.....	1	4931624351	SEAL RING
1232	a.....	2	4931621743	SCREW
1234	a.....	1	4931375508	FELT
1235	a.....	1	4931624381	O-RING
1236	a.....	1	4931307423	HOLDING-DOWN DEVIC
1237	a.....	1	4931386352	HOLDING-DOWN DEVIC
1238	a.....	2	4931624170	SEAL RING

Pos	Index	Quanti	Article No.	Designation
1241	a.....	2	4931267225	SCREW

Repairs/modification and testing of electric power tools are to be carried out by specialists. The safety regulations according to DIN/VDE/CEE/AFNOR and other regulations valid in the different countries are to be observed.